

REVISIONS				
REV	DATE	DRW'N	CHK'D	DESCRIPTION
A	27JUN17	GFC	DM	INITIAL RELEASE

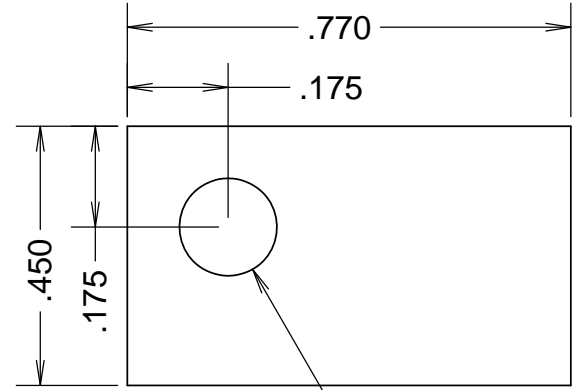

M4 CLEARANCE HOLE  
( $\phi$  .169 THRU ALL)

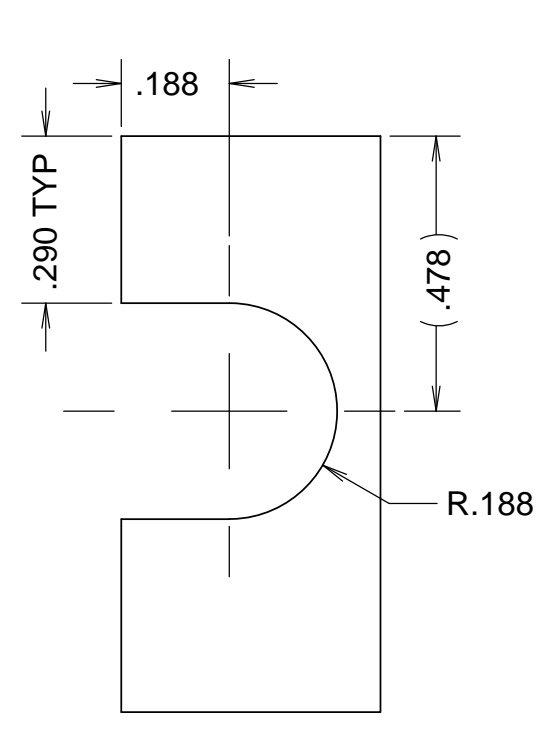
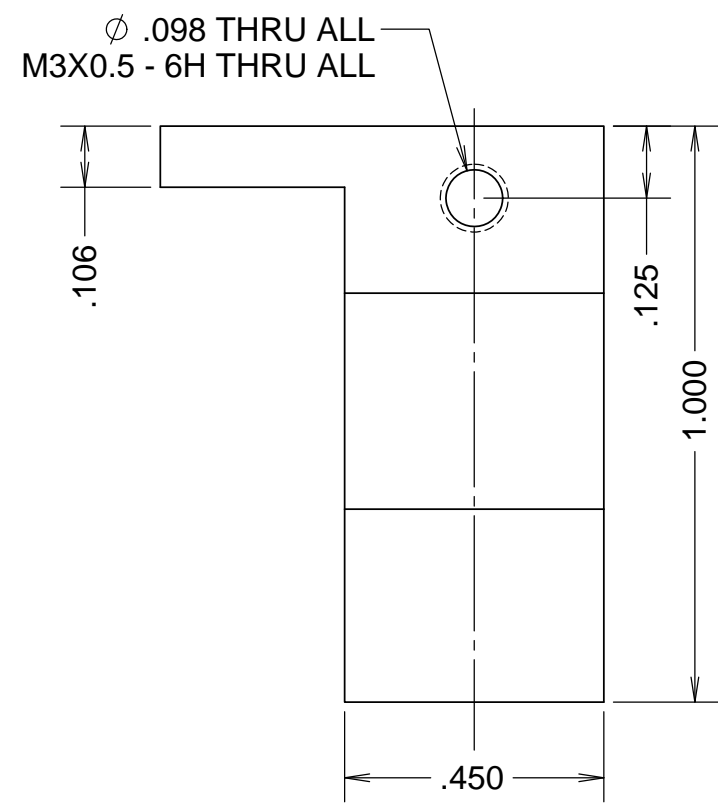
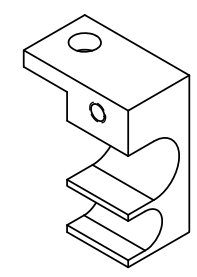
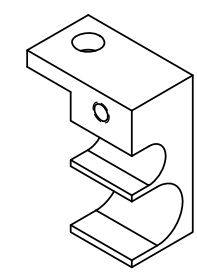
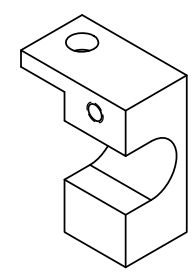

TYPE 1 -- 872-LM3153-01

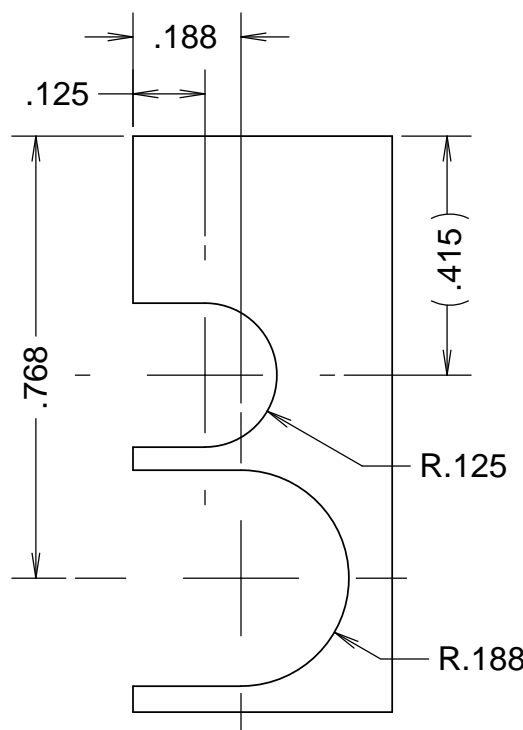

TYPE 2 -- 872-LM3153-02

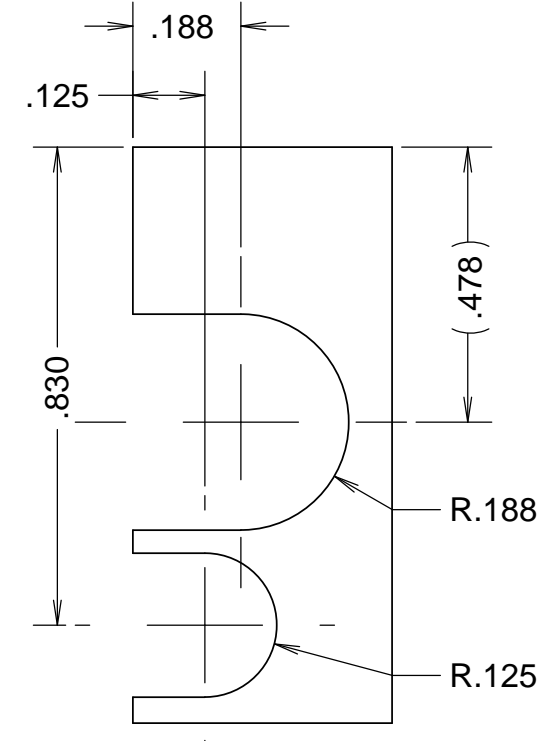

TYPE 3 -- 872-LM3153-03

**NOTES**

[1] CAD MODEL FILENAME, 872-LM3153 Tubing Clip

UNLESS OTHERWISE NOTED DIMENSIONS ARE IN INCHES & TOLERANCES ARE AS FOLLOWS

X.X: $\pm 0.1000''$	X.XX: $\pm 0.0100''$
X.XXX: $\pm 0.0050''$	X.XXXX: $\pm 0.0001''$
ANGLES: $\pm 0.5^\circ$ FINISH: 125 MICRO INCHES BREAK ALL SHARP EDGES & CORNERS .002" MAX	
MATERIAL: AL 5XXX/6XXX	FINISH: --

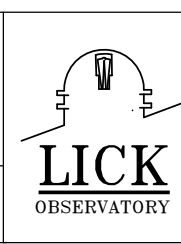

DRAWN: CABAK	--	KECK 1 DEPLOYABLE TERTIARY MIRROR
CHECKED: MARQUES	--	OUTER DRUM COMPONENTS
DESIGNED: MARQUES	--	TITLE: TUBING CLIP
APPROVED: CABAK	--	
SW DOCUMENT FILE: [1]	PROJECT CODE: K1D3FD	DWG NO: 872-LM3153
	NEXT ASSY: --	A/1